

BOMANN®

HOUSEHOLD-

FRIDGE- / FREEZER

KG 183

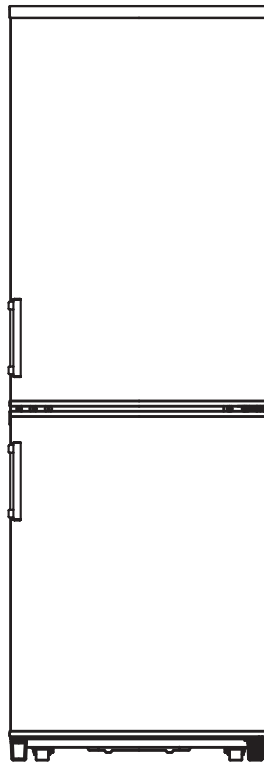

Instruction Manual

CE

Contents

Introduction.....	Page 3
General Notes.....	Page 3
Special safety information for this unit.....	Page 3
Unpacking the appliance.....	Page 5
Overview of the appliance.....	Page 5
Installation.....	Page 6
Reverse the door opening.....	Page 7
Startup / Operation.....	Page 9
Tips for Energy saving.....	Page 12
Cleaning.....	Page 12
Repairs.....	Page 13
Troubleshooting.....	Page 13
Technical Data.....	Page 15
Disposal.....	Page 16

Introduction

Thank you for choosing our product. We hope you will enjoy using the appliance.

Symbols in these Instructions for Use

Important information for your safety is specially marked. It is essential to comply with these instructions in order to avoid accidents and prevent damage to the machine:

 **WARNING:**

This warns you of dangers to your health and indicates possible injury risks.

 **CAUTION:**

This refers to possible hazards to the machine or other objects.

 **NOTE:** This highlights tips and information.

General Notes

Read the operating instructions carefully before putting the appliance into operation and keep the instructions including the warranty and the receipt. If you give this device to other people, please also pass on the operating instructions.

- The appliance is designed exclusively for private use and for the envisaged purpose. This appliance is not fit for commercial use.
- The appliance is only to be used as described in the user manual. Do not use the appliance for any other purpose. Any other use is not intended and can result in damages or personal injuries.
- Do not use it outdoors. Keep it away from sources of heat, direct sunlight and humidity.
- When cleaning, for user maintenance work or with disruption, switch off the appliance and always pull out the plug from the socket (pull the plug itself, not the lead).
- The device and the mains lead have to be checked regularly for signs of damage. If damage is found the device must not be used.
- For safety reasons, alterations or modifications of the device are prohibited.
- In order to ensure your children's safety, please keep all packaging (plastic bags, boxes, polystyrene etc.) out of their reach.

 **WARNING:**

Do not allow small children to play with the foil. There is a **danger of suffocation!**

Special safety information for this unit

- This unit is intended to be used in household and similar applications such as
 - staff kitchen areas in shops, offices and other working environments;
 - farm houses and by clients in hotels, motels and other residential type environments;
 - bed and breakfast type environments;

- catering and similar non-retail applications.

 **WARNING:**

- Keep ventilation openings, in the appliance enclosure or in the built-in structure, clear of obstruction.
- Do not use mechanical devices or other means to accelerate the defrosting process.
- Do not damage the refrigerant circuit.
- Do not use electrical appliances inside the food storage compartments of the appliance.
- Do not store explosive substances such as aerosol containers with flammable propellant in the appliance.
- This appliance can be used by **children** aged from 8 years and above and persons with reduced physical, sensory or mental capabilities or lack of experience and knowledge if they have been given supervision or instruction concerning **use of the appliance** in a safe way and understand the hazards involved.
- **Children** shall not play with the appliance.
- Cleaning and **user maintenance** shall not be made by **children** unless they are older 8 years and supervised.
- Do not try to repair the appliance on your own. Always contact an authorized technician. To avoid the exposure to danger, always have faulty cable be replaced only by the manufacturer, by our customer service or by qualified person and with a cable of the same type.
- Use the provided collection points of electrical equipment for the disposal of the appliance.

Coolant

 **WARNING:**

The coolant circuit of this device contains the refrigerant Isobutane (R600a), a natural gas that is flammable and of high environmental compatibility. Make sure no parts of the coolant circuit get damaged during transport and installation of the device.

If the coolant circuit is damaged:

- It is imperative to avoid any open flames or ignition source.
- Thoroughly air the room in which the device is installed.

Unpacking the appliance

1. Remove the appliance from its packaging.
2. The device and parts of the interior are protected for transport. Remove all adhesive tapes from the unit door. You may remove adhesive residue with a cleaning solvent. Also remove any adhesive tapes and packaging materials from the inside of the device.
3. To prevent hazards, check the appliance for any transport damage.
4. In case of damage, do not put the device into operation. Contact your distributor.

i NOTE:

Production residue or dust may have collected on the appliance. We recommend cleaning the appliance according to chapter "Cleaning".

Overview of the appliance

i NOTE:

The drawing can deviate from the original device.

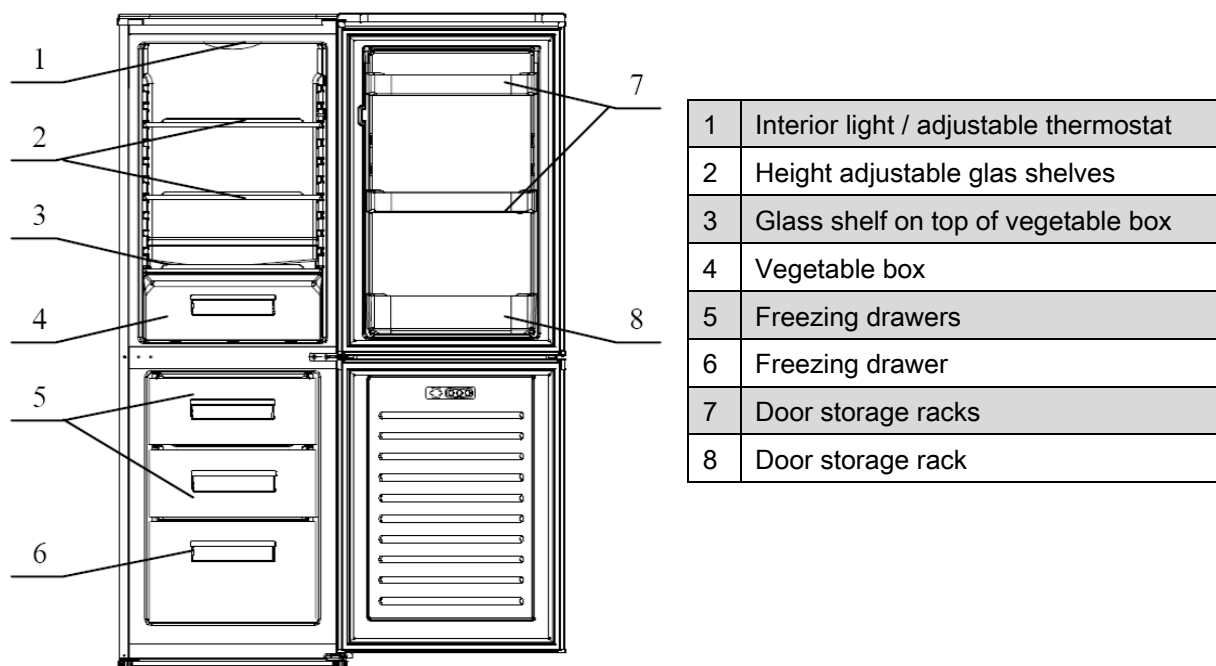

Delivery scope

- | | |
|------------------------------------|---------------------|
| 3 x height-adjustable glass shelf | 2 x egg tray |
| 1 x vegetable box with glass cover | 3 x freezing drawer |
| 4 x door storage rack | 1 x ice-cube tray |

For the reverse of the door opening:

- | | |
|-------------------|----------------------|
| 1 x blind cap (A) | 1 x door stopper (3) |
|-------------------|----------------------|

Installation

Conditions for the installation location

- Sufficient ventilation around the device is necessary in order for the heat to dissipate properly and to guarantee efficient cooling operation at low power consumption. For this purpose, leave sufficient space around the device.
 - minimum distance of 7,5 cm between rear side and wall;
 - at least 10 cm on both sides;
 - and on top of the device 10 cm.
 - Leave proper space in front of the device in order to open the door at an angle of 160°.
- Only install at a location with an ambient temperature suitable for the climate class of the device. For information on the climate class, please refer to chapter “Technical Data” or to the rating label located in the interior or on the rear side of the device.
- Place the device on a steady and safe surface. If the device is not horizontally leveled, adjust the feet accordingly.
- Install the device for the wall socket to be freely accessible.
- **Avoid the installation:**
 - near heaters, next to a stove, direct sunlight or any other heat sources;
 - at locations with high humidity (e.g. outdoors, bathroom), as metal parts would be susceptible to corrosion under such circumstances;
 - near volatile or flammable materials (e.g. gas, fuel, alcohol, paint, etc.) and in rooms which may have poor air circulation (e.g. garages).

Electrical connection

WARNING

For your personal safety:

- Do not use an extension cord or an adapter plug.
- Do not, under any circumstances cut or remove the earthing connection from the power cord.

CAUTION:

In case you disconnect the device or in case of power failure: Wait for 5 minutes before restarting the device.

- Make sure that the mains voltage to be used matches that of the device. You can find this information on the rating label of the device.
- Connect the device to a duly installed protective contact socket.
- Let replace the contact socket by an authorized specialist if this is not suitable for the power plug.

Reverse the door opening

If required, the door openings can be moved from the right (supplied condition) to the left side. We recommend consulting one more person for assistance.

⚠ WARNING:

When replacing the door stops, the device must be disconnected from the power supply. Always unplug the device first.

⚠ CAUTION:

- It is **NOT** allowed to lay the device horizontally for changing the door opening.
- Remove or secure the door racks and glass shelves from possible damages.

ℹ NOTE:

You need: screw wrench no. 8, Phillips screwdriver as well as a thin-blade screwdriver.

1. Use the flat thin-blade screwdriver to remove the screw covers at the device cover.

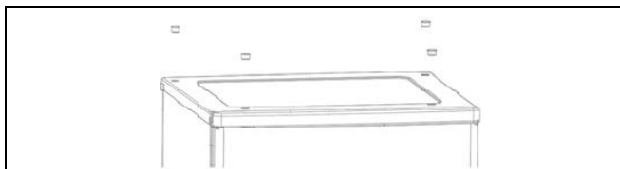

2. Unscrew the below screws and remove the device cover.

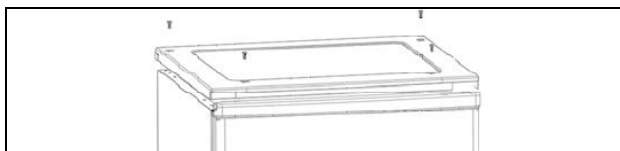

3. Put the blind cap of the device cover at the opposite side.

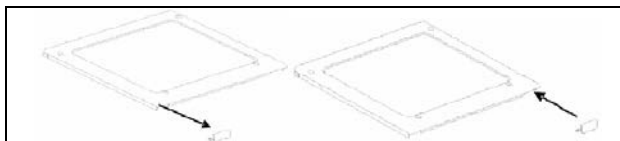

4. Dismount the upper door hinge by removing the hinge cover and unscrewing the screws. Open the fridge door a little and take the door carefully from the middle door hinge.

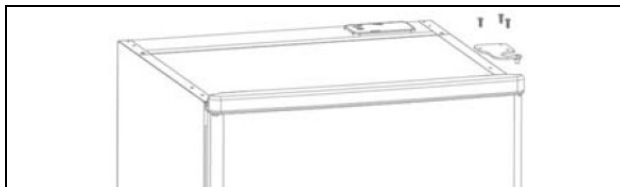

5. Remove the blind cap (B) of the fridge door. Insert the blind cap (A) contained in the delivery scope.

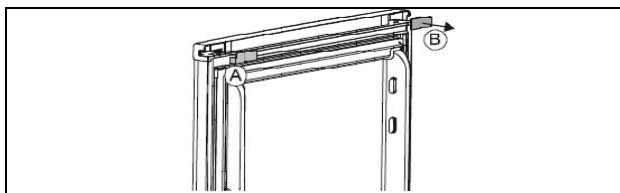

6. Loose the screw (1) and remove the door stopper (2) of the fridge door. Fix the door stopper (3) contained in the delivery scope with the screw (1). Place the door on a padded surface to avoid damages.

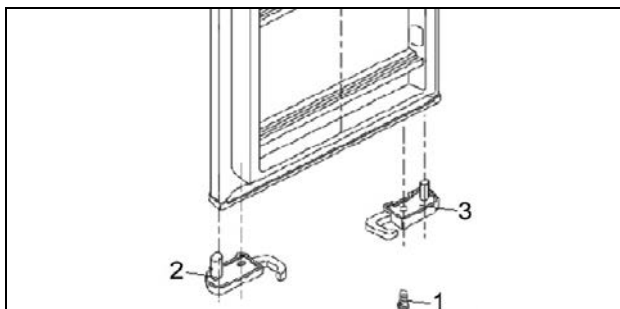

ℹ NOTE:

Keep the blind cap (B) as well as the door stopper (2) for a further possible door opening reverse.

7. Dismount the flange-screws of the middle hinge. Take the freezer door from the lower door hinge and place it on a padded surface too.

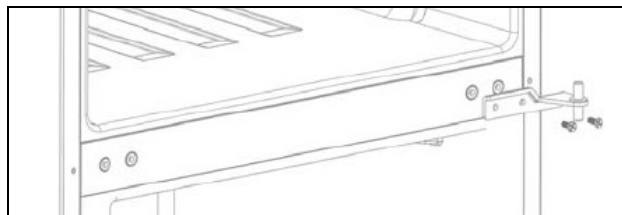

8. Put the cover caps at the opposite holes.



9. Tilt the device slightly backwards and block it in this position. Unscrew the feet and remove the foot bracket and the door hinge by loosening the screws.

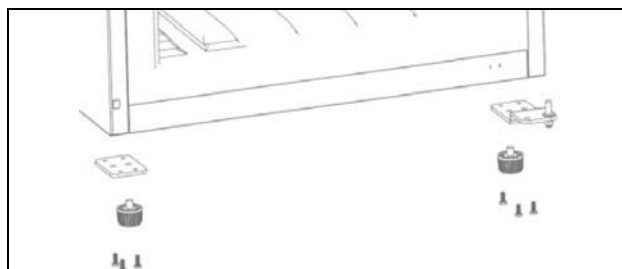

10. Unscrew the hinge pin and insert it to the other side of the door hinge. Screw the foot bracket and door hinge each at the opposite sides and screw the feet on again.

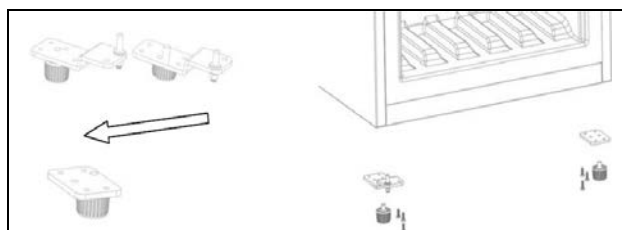

Replace the device upright. Insert the freezer door on the lower door hinge pin and fix the door to the property position.

11. Turn the middle hinge about 180° and transfer it at the opposite side. Put the hinge pin in the hole of the freezer door and tight the screws of the door hinge.

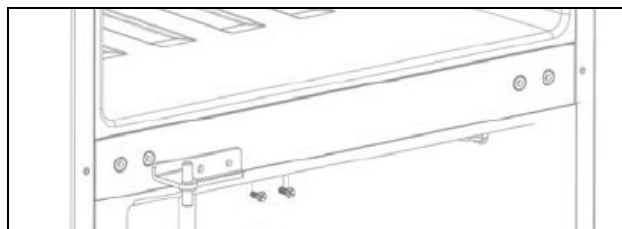

Insert the fridge door on the middle hinge pin and fix the door to the property position.

12. Transfer the upper hinge at the opposite side after you unscrewed the hinge pin and put it in from the other side of the door hinge again.

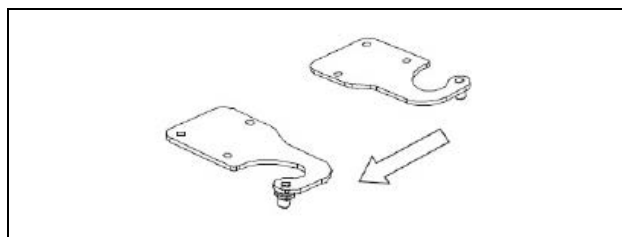

13. Put the hinge pin in the hole of the fridge door and tight the screws of the hinge. Put them in point 1 removed device cover on again, tight the screws and clip the cover caps on.

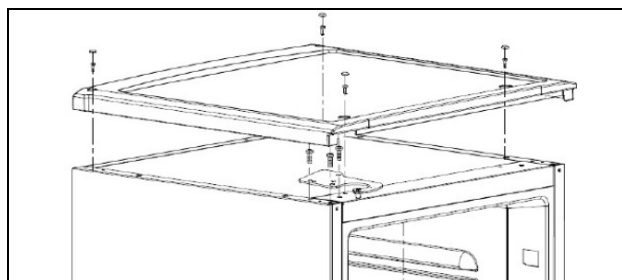

Check if the doors are arranged vertical as well as horizontal, so that a smooth opening and closing of the doors is ensured.

Startup / Operation

Prior to first use

CAUTION:

After transport, the device should be left standing for 4 hours in order for the oil to be collected in the compressor. Nonobservance could cause damage to the compressor and hence result in failure of the device. This would void your warranty claim.

- Clean the interior of the device including all accessory parts located inside. Please consider the instructions that we have included for you in the chapter on “Cleaning”.

Turning on

Turn on the device by connecting the plug to a wall socket and turning the temperature control, which is located in the fridge interior. Please also refer to chapter “Settings”.

Settings

Setting 0 – OFF indicates the device is turned off.

Turn the temperature control clockwise, starting from this setting; the device will turn on automatically.

The Settings 1 MIN – 7 MAX regulate the inside temperature. When opening the door, the interior lamp will turn on.

Setting 0 (or OFF)	=	Off
Setting 1 (or MIN)	=	lowest setting (warmest inside temperature)
Setting 7 (or MAX)	=	highest setting (coldest inside temperature)

Turning the temperature control clockwise will lower the inside temperature. Please keep in mind that the temperature changes with the ambient temperature (of the location), with the frequency of opening the door and the amount of food in the device.

During initial operation, turn the temperature control to the highest setting first, until the device has reached the desired operating temperature. Afterwards it is recommended to turn the control back to a medium setting; correcting the temperature at a later point would then be easier.

Storing food

Fridge

NOTE:

Always store food covered or packed in order to prevent drying-out and transfer of odor or taste onto other food items.

You may pack the food with:

- Polyethylene plastic bags or foil
- Plastic containers with a lid
- Special elasticated plastic covers
- Aluminum foil

The following safety precautions are recommended

- The device is suitable for storing fresh food and drinks.
- Store fresh packed items on the glass shelves and fresh fruits and vegetables in the vegetable box.
- Place bottles in the door storage rack.
- Store meat well packed and only for 2 to 3 days. Avoid contact with cooked dishes.
- Let warm food cool down before putting it in the device.

Freezer

The  freezer allows you to store frozen food at a temperature of -18°C or below (from a middle temperature control setting) for several months, to produce ice cubes and to freeze fresh good.

The temperature of the device is automatically controlled by the temperature control in the fridge.

Due to external influences such as room temperature, placements, frequency of opening the door and the amount of food the temperature in the freezer can be influenced.

Freezing

- 24 hours before freezing we recommend turning the temperature control to the max. setting and to keep this setting even after freezing for a few hours.

The device is not compromised if the setting will not revert to a normal operating temperature (temperature control in middle setting) after the freezing process, but for economic reasons you should possibly avoid it.

- Place fresh food to be frozen in the upper compartment. In order for that to be always possible, frozen food items need to be rearranged frequently.
- Fresh food should be frozen as fast as possible to the core. Therefore during freezing operation, the temperature of fresh food should be lowered as fast as possible in order to keep formation of ice crystals as little as possible and not to damage the food structure.
- If the freezing process is too slow, ice crystals build up and the food quality might get affected.
- Even frozen food should be stored in the lower compartments, in order to keep the upper compartment available for fresh food.
- Frozen food should be kept in contact with the bottom of the compartment.
- Keep a space between the single items for air circulation.

Storing frozen food

- Packed frozen merchandise should be stored in a 4-star-freezer compartment in accordance with the manufacturer's data. Make sure the food items do not defrost after purchase and to store them as fast as possible in the freezer.
- It is possible to store food for longer periods of time, up to three months. This period might vary, so please observe the storage information on the packaging of the merchandise.

 NOTE:

Make sure that the temperature in the freezer does not rise above -18°C.

Moreover the device should be defrosted regularly. A thick layer of ice on the wall deteriorates the cooling effect and the power consumption increases.

Safety precautions

- Do not store sizzling drinks in this device, such as mineral water, beer, sparkling wine, coke etc. (risk of explosion).
- Once products have been defrosted halfway or completely, they should be consumed as soon as possible and should not be frozen again, except they have been processed to a ready meal.
- In case of power failure, do not open the door. If the failure does not take longer than 15 hours, the food will not be affected.
- Do not store bottles or cans. These can break when the contents freeze – or even explode, if they contain carbonated drinks.
- Do not eat food that is still frozen. Do not allow children to eat ice cream directly from the freezer. The cold can cause injuries in the oral cavity.
- Touching metal parts inside the device can cause symptoms similar to burns if the skin is very sensitive.
- Do not touch frozen food with moist or wet hands; they could freeze to the items.
- For safety reasons, the freezer compartments feature a stopper. But they can also be removed completely by pulling them upwards and then removing them. Reattach in reverse order.

Defrosting

The **fridge** has an automatic defrosting system. During defrosting the water drops drain off at the rear side of the cooling chamber. The water running through a flume, is collected in a container underneath the compressor, where it will evaporate. Make sure the water discharge opening does not get clogged. Clean it carefully with a pipe cleaner or knitting needle. A light formation of ice on the rear side during operation is normal.

To achieve better cooling and to save energy, defrost the **freezer** regularly. To start the defrosting process turn the temperature control to the position 0 - OFF and disconnect the plug. Remove the food items and keep covered at a cool location. When the ice has melted, pour the condensate away and dry the interior of the device. You may then restart the device by connecting the plug and turning the temperature control.

CAUTION:

Never use metal objects (e.g. knives) for removing ice from the vaporizer. The vaporizer could be damaged. A defect vaporizer could cause serious damages.

NOTE:

In order to speed up the defrosting process you may put a bowl of warm water (about 50°C) into the freezer chamber.

Operating noise

	Type of sound	Cause / solution
Normal noise	Mumbling	Caused by the compressor during its operation. This is stronger when it turns on or off.
	Liquid sounds	Caused by the circulation of the refrigerant in the device.
	Click sounds	The temperature control turns the compressor on or off.
	Disturbing noises	Vibration of the shelves or cooling coils – check if those are securely fastened.

Turning off

Turn the temperature to setting **0 - OFF** in order to turn off the device.

If the device will not be operated for a longer period of time:

- Remove the entire food from the device.
- Turn the temperature control to setting 0 - OFF.
- Disconnect the plug or turn off / unscrew the fuse.
- Thoroughly clean the device (see “Cleaning”).
- Keep the door open in order to prevent bad odors.

Tips for Energy saving

- Disconnect the plug if you do not use the device.
- Do not install the device near stoves, heaters or other heat sources. In case of higher ambient temperatures, the compressor will run more frequently and longer.
- Ensure sufficient ventilation at the bottom and rear side of the device. Never block any ventilation openings.
- Allow warm dishes to cool down before putting them in the device.
- Do not open the door longer than necessary.
- Do not adjust the temperature colder than necessary. The ideal temperature in the fridge is 7°C.
- Make sure that the temperature in the freezer does not rise above -18°C.
- The device should be defrosted regularly.
- Make sure the door sealing is in good order for the door to close properly.

Cleaning

For hygienic reasons, clean the interior and accessory parts regularly.

WARNING:

- Always turn off the device and disconnect the plug or turn off / unscrew the fuse before cleaning and user maintenance.

- Do not use steam cleaners for cleaning the device; moisture could enter electrical components. **Risk of electric shock!** Hot steam could damage the plastic parts. The device must be dry before restarting operation.

△ CAUTION:

- Do not use a wire brush or any abrasive items.
- Do not use any acidic or abrasive detergents.
- Essential oils and organic solvents, such as the juice of lemon or orange skin, butanoic acid or cleaning agents containing acetic acid can damage plastic parts. Prevent contact of any part with such substances.
- Do not bend the cooling coils.

Please do as follows:

- Remove all food and keep covered at a cool location.
- Use warm water and a mild detergent for cleaning the interior (including rear side and bottom).
- Clean the water discharge opening carefully with a pipe cleaner or knitting needle
- After everything was thoroughly dried, you can restart the operation.

Repairs

A wrong or improperly performed repair brings danger to the user.

Repairs to electrical appliances must only be carried out by an authorized specialist. A damaged power cord must be changed only by a qualified electrician.

LED light

△ CAUTION:

Do **NOT** remove the cover of the LED light.

The LED light may be replaced / repaired in case of failure / defect only by an authorized specialist.

Troubleshooting

Before you contact an authorized specialist

The following problems can be solved by you by checking for the possible cause.

Problem	Possible cause	Solution
The device is not working properly or at all.	Is the unit not connected to mains power?	Insert the plug properly in the contact socket. Check the fuse.
	Is the temperature control properly set?	Check the temperature setting.
	Is the place unqualified?	Check the ambient temperature.
	Do food items or shelves and/or drawers prevent the door from closing properly?	Arrange the food or shelves and/or drawers properly.

Problem	Possible cause	Solution
The device is not working properly or at all.	Are the ventilation openings clear of obstruction?	Unblock the ventilation openings, install the device freely.
Device cools too much.	Is the temperature control set properly?	Check the temperature setting.
The food is too warm.	Is the temperature control set properly?	Check the temperature setting.
	Was the door open for an extended period?	Open the door only as long as necessary.
	Was large quantity of warm food placed in the appliances within the last 24 hours?	Turn the control panel to a colder setting temporarily.
	The appliance is near a heat source.	Check the installation location (see "Installation").
Loud noise during operation.	Does the device not stand vertical or horizontal?	Adjust the feet accordingly. Liquid flow sounds in the cooling circuit are normal.
Water on the bottom.	Is the temperature control set properly?	Check the temperature setting.
	Is the water discharge opening blocked?	Clean the water discharge opening with a pipe cleaner or knitting needle.
Light does not work.	Is the unit not connected to mains power?	Insert the plug properly in the contact socket. Check the fuse.
	Is the light bulb defect?	Contact a specialist (see "LED light").
The sides of housing becomes warmly.	The device is not equipped with the conventional grating on the back. The refrigeration cycle takes place in the foaming. The heat exchangers are installed in the housing covered. The device does not generate cold, but cut the interior heat. This heat must be dissipated through the housing areas.	
Water on the outer surface.	On days of high humidity, condensation might occur on the outer surface of the device. This is no malfunction; you may simply wipe the water off.	

i NOTE:

If a problem still persists after following the steps above, please contact your distributor or an authorized technician.

Technical Data

Technical data of household refrigerators according to:
EU Directive (EU) 1060/2010

Brand		Bomann
Model		KG 183
Category ¹⁾		7
Energy efficiency class ²⁾		A+++
A+++ (highest efficiency) to G (lowest efficiency)		
Consumption data		
Annual energy consumption ³⁾	kWh	131
Net capacity cooling total	l	176
Net capacity freezing total	l	65
Start rating ⁴⁾		4
Frost-free		-
Temperature rinse time	h	15
Freezing capacity	kg/24h	3
Climate class ⁵⁾		
Noise level	dB(A) re 1pW	41
Design		Free standing
Measures / weights		
Height	cm	180,0
Width	cm	55,4
Depth	cm	56,3
Net weight	kg	59,0
Electrical connection		
Compressor		60 W
Connection voltage		220-240 V~, 50 Hz

1) Category: 1 = Refrigerator with one or more fresh-food storage compartments, 2 = Refrigerator-cellar, Cellar and Wine storage appliances, 3 = Refrigerator-chiller and Refrigerator with a 0-star compartment, 4 = Refrigerator with a one-star compartment, 5 = Refrigerator with a two-star compartment, 6 = Refrigerator with a three-star compartment, 7 = Refrigerator-freezer, 8 = Upright freezer, 9 = Chest freezer, 10 = Multi-use and other refrigerating appliances

2) A+++ (highest efficiency) to G (lowest efficiency).

3) Annual energy consumption „XYZ“ kWh per year based on standard test results for 24 h.

Actual energy consumption will depend on how the appliance is used and where is located.

4) * = compartment: a frozen-food storage compartment in which the temperature is not warmer than -6°C.

** = compartment: a frozen-food storage compartment in which the temperature is not warmer than -12°C.

*** = compartment: a frozen-food storage compartment in which the temperature is not warmer than -18°C.

*(***) = food freezer compartment in which the temperature is not warmer than -18°C and a min. freezing capacity in 24 h.

5) Climate class SN: ambient temperature of +10°C up to +32°C.

Climate class N: ambient temperature of +16°C up to +32°C.

Climate class ST: ambient temperature of +16°C up to +38°C.

Climate class T: ambient temperature of +16°C up to +43°C.

The right to make technical and design modifications in the course of continuous product development remains reserved.

All device-specific data of the energy label have been determined by the manufacturer under laboratory conditions in accordance with pan-European standardized measuring methods. These are regulated by **ISO EN 15502**. The actual energy consumption depends on the usage and might therefore also be above the values determined by the manufacturer under standard conditions.

An expert knows these relations and will execute the tests with special measurement instruments in accordance with the regulations in place.

This device has been tested according to all relevant current CE guidelines, such as electromagnetic compatibility and low voltage directives, and has been constructed in accordance with the latest safety regulations



Disposal

Meaning of the “Dustbin” Symbol

Protect our environment; do not dispose of electrical equipment in the domestic waste.

Please return any electrical equipment that you will no longer use to the collection points provided for their disposal.

This helps avoid the potential effects of incorrect disposal on the environment and human health.

This will contribute to the recycling and other forms of reutilization of electrical and electronic equipment.

Information concerning where the equipment can be disposed of can be obtained from your local authority.

WARNING:

Remove or disable any existing snap and bolt locks, if you take the device out of operation or dispose it.

BOMANN®

C. Bomann GmbH

www.bomann.de